

# PFA110

## Mount Adapter



### Features

- Material: Aluminum
- Mount Adapter
- Neat & Integrated design

### Specifications

Model	PFA110
<b>General</b>	
Material	Aluminum
Dimension (W x H x D)	Φ59mm x 53mm
Pipe Thread	G1 1/2"
Operating Temperature	-40°C ~60°C
Humidity	0~90% RH
Load Bearing	N/A
Weight	0.2kg
Applicable Model	Please see "Accessory Selection"

# PFA110

## Dimensions (mm)

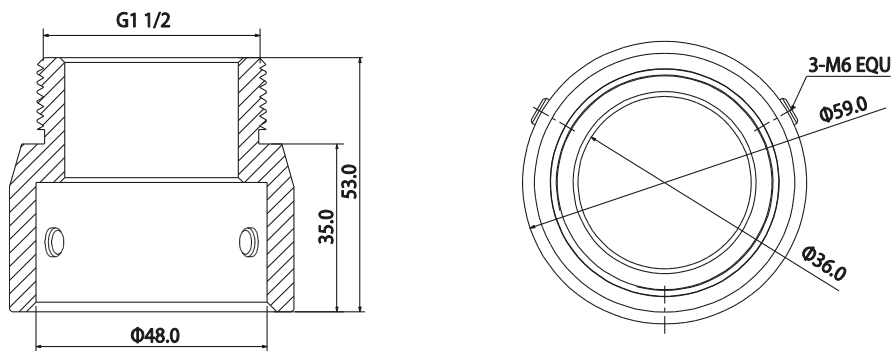

## Application

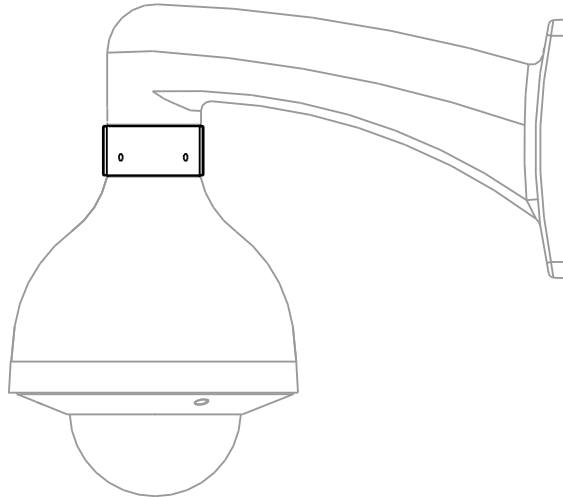

---

### Dahua Technology Co., Ltd.

1199 BinAn Road, Binjiang District, Hangzhou, China

Tel: +86-571-87688883

Fax: +86-571-87688815

Email: [overseas@dahuatech.com](mailto:overseas@dahuatech.com)

[www.dahuasecurity.com](http://www.dahuasecurity.com)

\*Design and specifications are subject to change without notice.

© 2013 Dahua Technology Co., Ltd.